

The PSW 1502W RC-12 inverter converts a 12 V battery into a 230 V power supply for any appliance up to 1500 W. Highly efficient in conversion, it makes a Pure Sine Wave type current adaptable to all the needs of even the most sensitive domestic appliances. Light and stable, it can be transported or permanently fixed. Its remote control allows remote management when the inverter is installed in a place not easily accessible.

### High quality Pure Sine Current 12 V

- The current reproduced by the inverter is **the same as** the current reproduced by the public network.
- No effect during voltage peaks, the inverter **automatically regulates** the required power.
- **Ideal for equipment sensitive to variations in current or high power.**



### High efficiency without energy loss

- Thanks to its **very high conversion rate** (90% max), the PSW 1502W RC-12 delivers more energy than a standard inverter.
- The remote control allows the converter to be switched off and to limit self-consumption when running empty. The battery does not discharge and **conserves all its energy.**

#### Supplied with:



### Handy and functional design

- **Compact** and equipped with a fastening system, these products are designed to be easily transportable or permanently installed in a vehicle.
- **2 connectors** for all electrical appliances:
  - 2 mains socket (230V)
  - 2 USB socket (5V)

### Safe to use

- Thermal protection, ventilated.
- Anti short-circuit protection.
- Undervoltage and overvoltage protection.







### Remote management thanks to its remote control

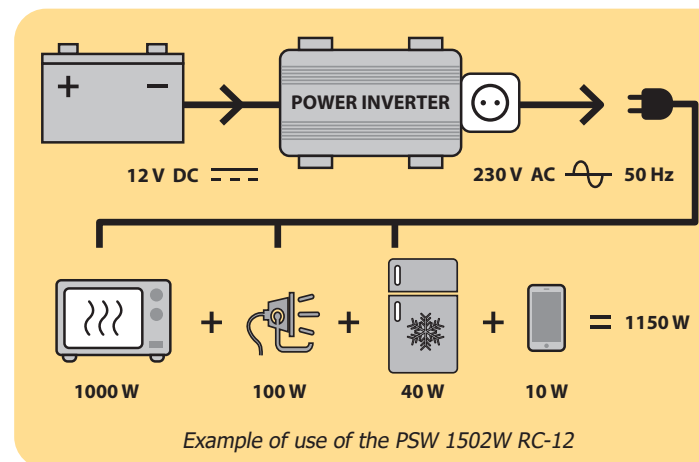

Supplied with the inverter, this remote control can be fixed at 6 m thanks to its long distance cable. It has three functions:

- Control the inverter remotely with its On/Off button.
- Warn by an indicator light in case of a fault.
- Provide information on battery status and power consumption via its digital display.



Power	Peak Power	Pure Sin Wave	Optimum Efficiency	Input DC	Output AC	Output USB DC		 Universal					
1500 W	3000 W	▪	90%	12 V	230 V	5 V - 2 A	16 mm <sup>2</sup>	▪	▪	▪	-	375 x 210 x 100 mm	4.3 kg